

VON®

DESIGNED TO LOVE

CERAMIC HEATER, 2000W

VHT203DYAK



USER MANUAL

PLEASE READ CAREFULLY! BEFORE USING THE APPLIANCES
PLEASE KEEP IT HANDY FOR FUTURE USE!

CERAMIC HEATER

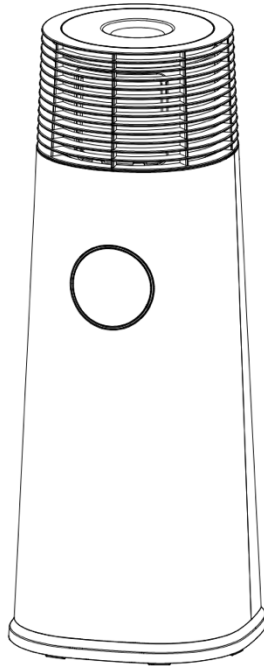

KPT-2000 5183L

This product is only suitable for well insulated spaces or occasional use.

INTRODUCTION

- Before using your new heater, please carefully read through the following instructions. KEEP THIS BOOKLET IN A SAFE PLACE SO THAT YOU MAY CONSULT IT LATER.
- After removing the packaging, make sure that the appliance is in good condition.
- The packaging materials may contain plastic, nails etc., which may be hazardous and therefore should not be left within the reach of children.

IMPORTANT SAFETY INFORMATION

- Avoid installation behind a door.
- Use only the voltage specified on the rating plate of the heater.
- Do not cover or restrict airflow to the inlet or exhaust grilles in any manner as the appliance may overheat and become a fire risk (for Fan Heaters).
- Do not cover grilles, block entry or exhaust of airflow by placing appliance against any surface. Keep all objects at least 1 metre from the front and sides of the appliance. With exception of appliances designed for wall-mounting, maintain a 1 metre gap from the rear of the unit as well.

WARNING: FIRE RISK EXISTS IF THE HEATER IS COVERED BY OR POSITIONED CLOSE TO CURTAINS OR OTHER COMBUSTIBLE MATERIALS

- Do not place appliance close to a radiant heat source.

- Do not operate in areas where gasoline, paint or other flammable liquids are used or stored.
- This appliance heats up when in use. To avoid burns, do not let bare skin touch hot surfaces. Switch off and use handles where provided when moving.
- Do not use the appliance to dry clothes.
- Do not leave the appliance unattended whilst in use.
- Do not insert or allow foreign objects enter any ventilation or exhaust opening, as this may cause an electric shock, fire or damage to the appliance.
- Do not immerse in liquid or allow liquid to run into the interior of the appliance, as this could create an electrical shock hazard.
- Do not use this appliance on a wet surface, or where it can fall or be pushed into water.
- Do not reach for an appliance that has fallen into water. Switch off at supply and unplug immediately.
- Do not operate any appliance with a damaged cord, plug or after the appliance malfunction or has been dropped or damaged in any manner. Return to a qualified electrical person for examination, electrical or mechanical adjustment, service or repair before further use.
- Do not operate appliance with wet hands.
- This appliance is intended for household use only and not for commercial or industrial use.
- Use this appliance only as described in this manual. Any other use is not recommended by the manufacturer and may cause fire, electric shock or injury.
- A common cause of overheating is deposits of dust or fluff in the appliance. Ensure these deposits are removed regularly by unplugging the appliance and vacuum-cleaning air vents and grilles, where available.
- Do not use this appliance in a window as rain may cause electric shock.
- Do not use abrasive cleaning products on this appliance. Clean with a damp cloth (not wet) rinsed in hot soapy water only. Always remove plug from the mains supply before cleaning.
- Do not connect the appliance to the mains source until it has been installed in its final location and adjusted to the position it will be used in.
- This appliance is not intended for use in bathrooms, laundry or similar locations which may be exposed to water, moisture or humidity.
- Always operate on a flat horizontal surface.
- Switch off the appliance, then use handles (where provided) to change its position.
- Do not operate with the cord coiled up as this could cause a build up of heat, which could pose a hazard.
- The use of an extension cord with this appliance is not recommended.
- Do not remove the power plug from the socket by pulling the cord – grip the plug instead.
- Always unplug appliance when not in use.
- Do not allow cord to come in contact with heated surfaces during operation.
- Do not run cord under carpeting, throw rugs or runners etc. Arrange cord away from areas where it is likely to be tripped over.
- Do not twist, kink or wrap the cord around the appliance, as this may cause the insulation to weaken and split. Always ensure that the cord has been fully removed from any cord storage area before use.
- Do not store appliance in a box or closed space until it has cooled down sufficiently.
- This appliance is not intended for use by persons (including children) with reduced physical, sensory or mental capabilities, or lack of experience and knowledge, unless they have been given supervision or instruction concerning use of the appliance by a person responsible for their safety.
- Young children should be supervised to ensure they do not play with the appliance.
- The appliance must not be located immediately below a socket-outlet.
- Do not use this appliance with a programmer, timer or any other device that switches the heater on automatically, since a fire risk exists if the appliance is covered or positioned incorrectly.
- If the supply cord is damaged, it must be replaced by a qualified electrical person in order to avoid a hazard.
- Do not use this appliance outdoors, or on wet surfaces. Avoid spilling liquid on the appliance.
- In order to avoid a hazard due to inadvertent resetting of the thermal cutout, this appliance must not be supplied through an external switching device, such as a timer, or connected to a circuit that is regularly switched on and off by the utility.
- For additional protection, the use of a Residual Current Device (RCD) with a tripping current not exceeding 30mA is recommended.

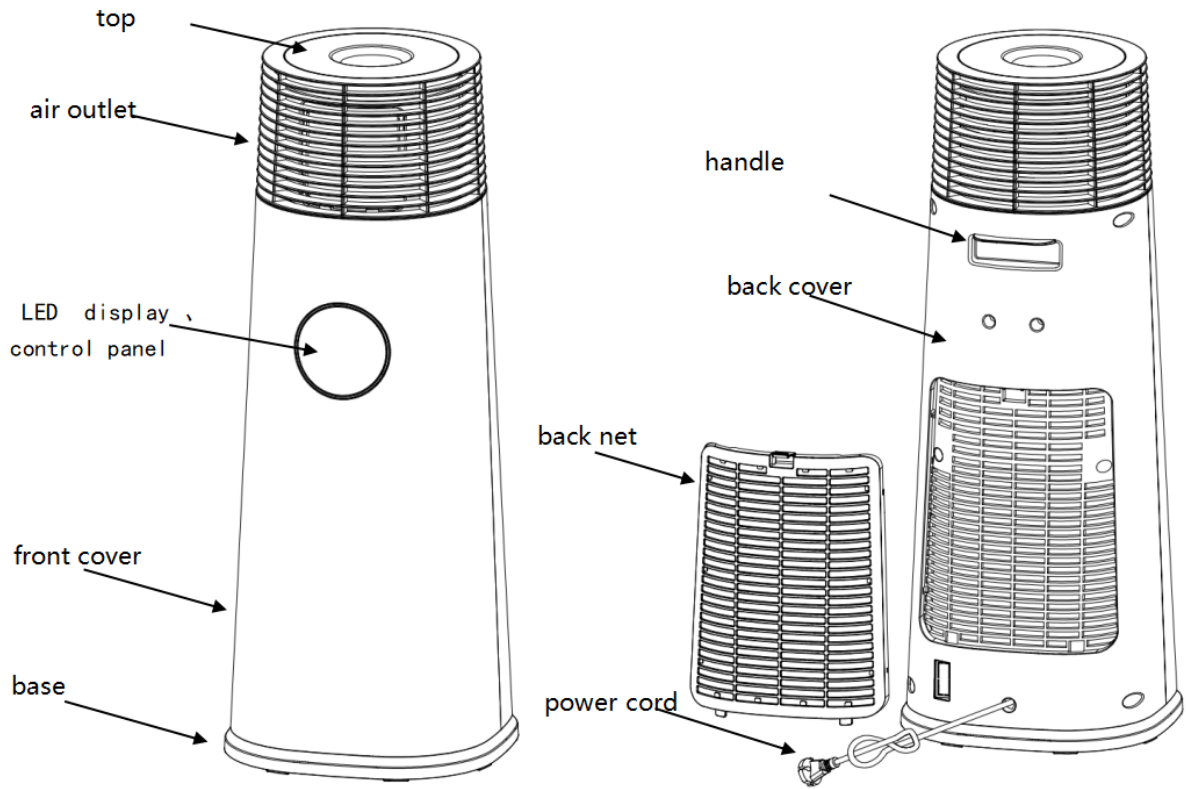





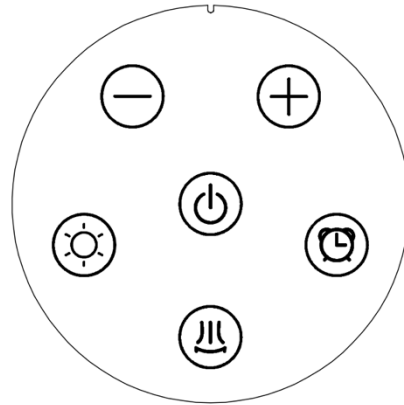





OPERATION AND DISPLAY











REMOTE CONTROL







1. Before inserting the plug into an electrical outlet, make sure that the electrical supply in your area matches that on the rating label on the unit.
2. Carefully remove the heater from the plastic bag and the carton.
3. Place the heater on a firm level surface
4. Setting the master button to "off".plug the cord set into a 220-240v~AC electrical outlet.Turning the master button "on" position.
5. Turn the heater ON by pressing the  main button at the back side of the heater.The unit will display the current Room

temperature.

6. And then by pressing the "  "button, the unit will start heating working .
7. You can press the control button "  " on the body or the "  " button on the remote control to choose mode .The heater in the order of "2 low heating -3 high heating-1 fan" in circle and the display screen displays the current mode(heating icon is not displayed during fan mode)
8. Press the "  " button on the body control button or the "  " and "  " buttons on the remote control to enter the temperature setting mode. The default setting temperature is 25 °C, and the temperature setting range is 10-35 °C. After setting the temperature, the heater intelligently selects the heating mode for operation. When the ambient temperature reaches the set temperature, the product stops heating; When the ambient temperature is lower than the set temperature, the product starts heating mode. If you want to select a specific heating mode, you can press the "  " button to cancel the temperature setting mode; After setting, switch to the current mode within 3 seconds.
9. pressing "  " on the body control panel or on the remote control ,you can set the timer from 0-12 hours.The display screen display "  " .
10. By pressing "  ",you can make the heater with or without oscillation.

In working mode, press the control button "  " on the body or on the remote control, press one time the "  " light on the display screen and turn on the 60 degree, light "  ", press two time the "  " light on the display screen twice and turn on the 90 degree light "  ", press the "  " light on the display screen three times and turn on the 180 degree light "  ", press the "  " light on the display screen four times and turn on the 360 degree light "  ", press the "  " light on the display screen five times to turn off the shaking head, This cycle

Swing angle light	icon
60°	
90°	
180°	
360°	

11. Screen shutdown function :During working state,no operate it for three minutes,all functions remain unchanged ,and it will enter into automatic screen shutdown mode .In this mode,press any button (including the remote control) to cancel the mode.
12. Memory function :The product has a memory function for power and temperature settings .Turn off the product while powered on .The product have memory for previous setting (the time function will not suitable)

SPECIFICATIONS

Power Supply: AC 220-240V ~ 50Hz

Power Consumption: 2000W

NOTE: As a result of continual improvements, the design and specifications of the product within may differ slightly to the unit illustrated on the packaging.

Environment

Meaning of crossed-out wheeled dustbin:



Do not dispose of electrical appliances as unsorted municipal waste, use separate collection facilities. Contact your local council for information regarding the collection systems available.

If electrical appliances are disposed of in landfills or dumps, hazardous substances can leak into the groundwater and get into the food chain, damaging your health and well-being.



Hotpoint

HEAD OFFICE

Sukari Industrial Estate-Off Thika Highway
Exit 10-next to Kenyatta University
P.O Box 402-00606, Nairobi, Kenya
TEL: +254-20-3699000
info@hotpoint.co.ke

OUR OUTLETS

Sarit Centre, Garden City, Village Market, CBD, Imaara
Mall, Riara, Karen Binaa Complex, Yaya Centre

Likoni Mall

Tel: +254-20-3699500

Nyali Centre

Tel: +254-20-3699700

Eldoret - Rupa Mall

Tel: +254-20-3699650

Kisumu - Mega City Mall

Tel: 020 3699850

Rwanda Head Office

Plot #624, KK 10 AVE,

Tel: +250788381774

SERVICE CENTRES

Sarit Centre-Westlands, Nairobi

Tel: +254-20-3699000

Email: servicesarit@hotpoint.co.ke

Sukari Industrial Estate-Off Thika Highway

Exit 10-next to Kenyatta University

Tel: +254-20-3699400

Email: svcruiru@hotpoint.co.ke

Mombasa-Likoni

Tel: +254-799 996996/ 799 996990

+254-20-3699550

Email: servicemsa@hotpoint.co.ke

VON®

DESIGNED TO LOVE

Appliances & Electronics you're proud to own



Follow us on IG & Tik Tok: [Von_designedtolove](#) & FB: [VON](#)

Customer Care: 0800720404

VON HOME APPLIANCES WARRANTY

VON provides a 12 months warranty for this product from the date of purchase.

TERMS & CONDITIONS:

<p>1 The warranty is valid for 12 months from the date of purchase.</p> <p>2 This card must be completed and returned for registration of the promised warranty to M/S Hotpoint Appliances Ltd within two weeks of purchase, failing to which this warranty will be deemed to be null and void.</p> <p>3 Warranty is given that the product recorded above is free from factory faults and any defect which in our judgment is due to manufacturing will be serviced free-of-charge and faulty part(s) will be replaced, not the product. This warranty is a quality assurance warranty and applicable for repairs and service as stated. This is not a replacement warranty.</p> <p>4 All customers are strongly advised to protect their equipment from damaging power surges and dips with the recommended voltage stabilizers. Damage occurring to the equipment in the event of failure to do so will void this warranty. All products must be installed correctly according to the instructions stated in the manual and must be used solely for purposes intended/designed. Electrical damage caused by power supply other than the specified voltage and cautions will not be covered by this warranty. Similarly, damage caused by lightning /power surges/ transformers/ high voltage will not be covered by this warranty.</p> <p>5 This warranty applies only to VON branded products that have been purchased within Kenya from either M/S Hotpoint Appliances Ltd or any of our authorized dealers.</p> <p>6A This warranty does not cover plastic parts, ordinary wear and tear, tampering and repairs undertaken by unauthorized sources without prior permission of M/S Hotpoint Appliances Ltd, negligence or accident or cases where original serial number of the product purchased has been altered or erased or removed.</p> <p>6B This warranty does not cover accidental damages, misuse or abuse, to the cabinet parts, knobs or consumable items such as batteries, belts, bulbs, glass, trays, taps, and others.</p> <p>6C This warranty will be rendered invalid if the item is misused/tampered and or damaged by an unauthorized individual/institute during delivery, installation or repair.</p>	<p>7 Damage/fault caused by insects/pests is also not covered by this warranty.</p> <p>8 This warranty does not cover any transport related charges/costs to attend/deliver/collect any malfunctioning product. However, the return will be provided at no cost/charge if the item is under warranty and requires to be returned to the end user.</p> <p>9 No alteration will be accepted made on the warranty card as far as the model, serial numbers and the date is concerned.</p> <p>10 In case of the item being exchanged, this warranty card must be surrendered in exchange for another one.</p> <p>11 Any warranty claim must be accompanied with this warranty card; no claim would be accepted whatsoever without the original warranty card.</p> <p>12 Hotpoint Appliances Ltd shall endeavor in its best ability to repair within 48 (forty-eight) hours, subject to availability of manufacturer's recommended genuine parts. Should the said spares be not available, then in that event Hotpoint Appliances shall be absolved from its responsibility as this event shall be deemed as a Force Majeures.</p> <p>13 The purchaser agrees that the sole liability of Hotpoint Appliances Ltd with respect to defective goods shall be limited as set forth in this warranty and Hotpoint Appliances Ltd shall not be liable under any theory of relief, including breach of contract, negligence, strict liability, tort or otherwise for incidental consequential or other damages including but not limited to loss of profits, injury to property, or loss of use of the goods. In no event shall the liability of Hotpoint Appliances Ltd hereunder exceed the purchase price actually paid by purchaser for the goods. The foregoing warranty is in lieu of all the other expenses and implied warranties including, without limitation, warranties of merchantability and fitness for purpose.</p> <p>14 This warranty shall be subject to the Laws of Kenya.</p>
--	--

YOU MUST HAVE THE ORIGINAL WARRANTY CARD (OVERLEAF) DULY FILLED IN WITH THE ORIGINAL AUTHORISED DEALER'S STAMP (INDICATING DATE OF PURCHASE) ALONG WITH PURCHASE RECEIPT TO CLAIM THE WARRANTY SERVICE IN FUTURE.

PLEASE INDICATE THE PROBLEM CLEARLY TO THE RECEIVING PERSON AT THE SERVICE CENTER/ COLLECTION POINT TO ENABLE FASTER AND ACCURATE DIAGNOSIS.

THIS PRODUCT IS DESIGNED FOR DOMESTIC USAGE ONLY



WARRANTY CARD

(Please keep it duly filled and stamped in original, safe for future)

NAME:.....

.....

ADDRESS:.....

.....

TEL/MOBILE NO.EMAIL ID.....

P.O. BOX:

DATE OF PURCHASE:/...../.....

DEALER'S NAME, BRANCH & ADDRESS:

.....

INVOICE NO.....

DEALERS STAMP:

A large, rounded rectangular box with a thin black border, intended for a dealer's stamp. It is positioned below the 'INVOICE NO.' field and above the model number.

Model No.VHT202DYAK